

Model: P2D4-10

Type: DVC Subwoofer

Power Rating: 300 Watts (RMS)

Impedance: (2) 4 ohms



Features

- High modulus Kevlar™ re-inforced paper-pulp cone.
- Dual tear & fatigue resistant poly-cotton spider.
- Tall-profile VAST™ Santoprene™ surround
- High temp 2.25" voice coil w/ spun-laced Nomex™ insulating re-inforcement collar
- Optimized motor magnetics with extended pole and bumped vented backplate.
- Fatigue resistant and reduced strain "stitched on" flexible lead wire design.
- Proprietary spider venting/cooling technique
- Multi-point high-temp/high-strength neck joint bonding technique.
- Sturdy 16 guage compound bend frame geometry.
- Semi-flexible, PVC removable protective motor cover.
- Proprietary all metal, radially oriented compression input terminal assembly.
- Flex-fit™ Mounting pattern
- Die-Cast aluminum soft-touch painted trim ring allows for optional integrated grill

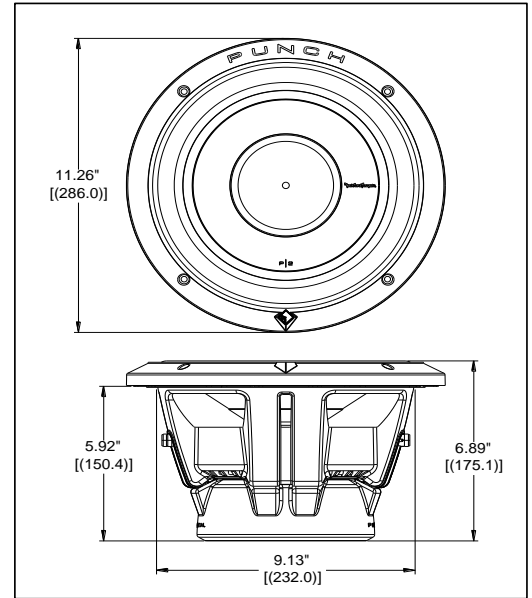

Recommended Applications

Enclosure	Volume (Vb)		Tuning(Fb)	System (Qtc)	-3dB (F3)	Port Dia.		Port Length	
	Liters	cu.ft.	Hz		Hz	in.	cm	in.	cm
Sealed:	16.7	0.59	63.1	0.93	46.3	-	-	-	-
Ported:	39.6	1.40	38.5	-	32.2	4.0	101.6	16.3	41.5

SPL & Excursion (at 300 Watts) / Impedance (at 1 Watt)

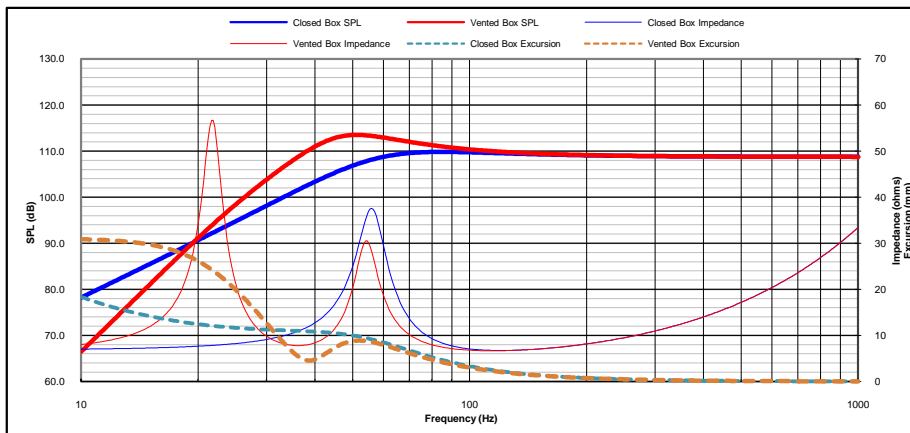

Thiele-Small Specifications

- Fs (Hz): 30.8
- Re (Ohms): 6.40
- Le (mH): 5.3
- Qts: 0.57
- Qes: 0.62
- Qms: 7.00
- Cms (mm/N): 0.19
- Vas (L): 35.4
- Mms (g): 140.2
- Mmd (g): 136.3
- Rms (kg/s): 3.9
- Airload (g): 3.9
- No (%): 0.15
- SPL (dB - 1W/1M): 84.0
- BL (T*M): 16.7
- *Xmax₁₀ (mm): 11.0
- Sd (cm²): 360
- EBP: 50
- Krm (mOhms): 0.84
- Erm: 1.26
- Kxm (mH): 53.1
- Exm: 0.76
- Rem (Ohms): 51.28

* All parameters are derived using a laser velocity measurement method and verified with actual measured Mmd and Re. All dual voice coil models are wired in series. Xmax₁₀ represents actual effective excursion at <10% THD.

Technical Specifications

Voice Coil Diameter:	2.25	57.15	inches mm
Voice Coil Height:	1.18	30.0	inches mm
Voice Coil Layers:	4		layers
Magnetic Gap Height:	0.39	10.0	inches mm
Linear Excursion, (Xmax):	0.40	10.0	inches mm
Maximum Excursion (mech), pk-pk:	2.25	57.2	inches mm
Magnet Weight:	66.4	1.88	oz. kg
Woofers Displacement:	2.5	0.088	liters cubic ft.
Net Weight:	12.3	5.6	lbs. kg
Power Rating:	300	600	RMS Peak

Above specifications and dimensions comply with the CEA-2031 standard.

Specifications subject to change without notice.